

ECN NO.	REV	DATE	DESCRIPTION	APP'D
	A0	2020-5-19	drawing release	kevin

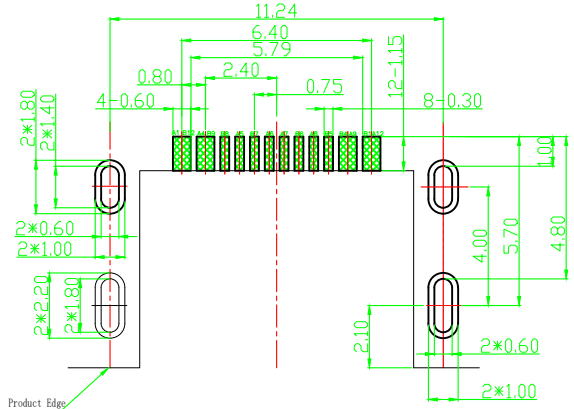

RECOMMENDED P.C.B. LAYOUT
TOLERANCE UNSPECIFIED ±0.05mm

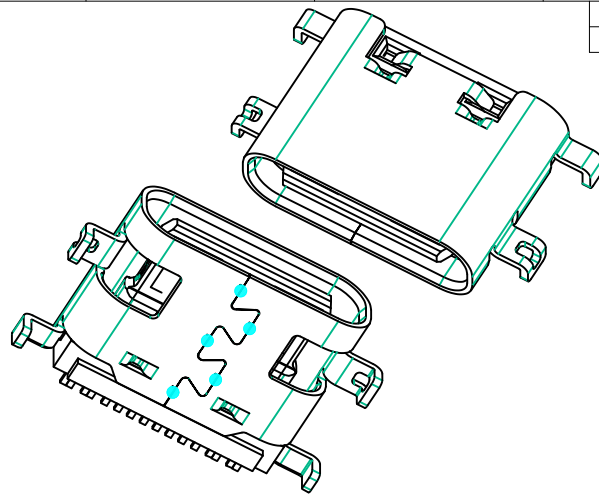
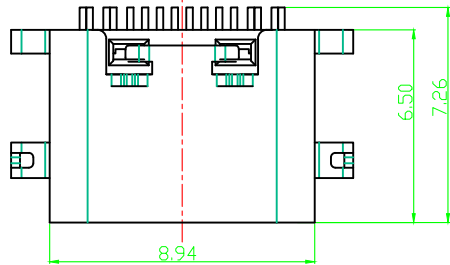
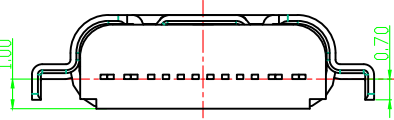
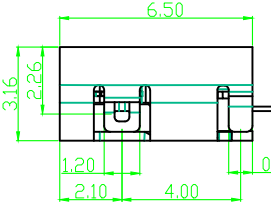
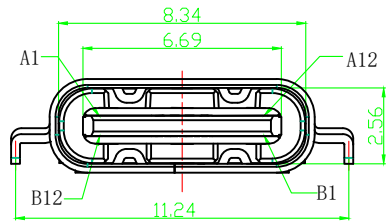

A1	GND	B12	GND
A4	VBUS	B9	VBUS
A5	CC1	B8	SBU2
A6	DP1	B7	DN2
A7	DN1	B6	DP2
A8	SBU1	B5	CC2
A9	VBUS	B4	VBUS
A12	GND	B1	GND
PIN	SIGNAL NAME	PIN	SIGNAL NAME

外壳增加点焊5处

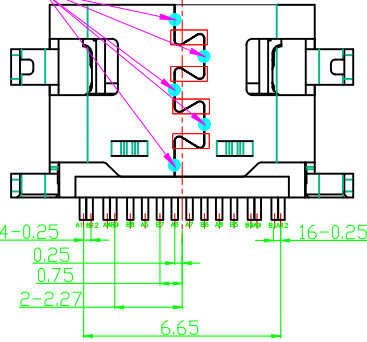

- NOTES:
SPECIFICATION:
- CURRENT RATING: 5.0A MAX
 - VOLTAGE: 100 VAC
 - TEMPERATURE RANGE: -30 °C ~ 85 °C
 - CONTACT RESISTANCE: 40 MILLIONHM MAX
 - INSULATION RESISTANCE: 100 MEGOHMS MIN.
 - INSERTION FORCE : 5N~20N
 - UNMATING FORCE: 8N~20N
 - DURABILITY: 10,000 CYCLES

6	SHELL	STAINLESS STEEL	NI Plated	1PCS
5	SHIELDING PLATE	STAINLESS STEEL	---	1PCS
4	MD	HIGH TEMPERATURE PLASTIC	BLACK	1PCS
3	CONTACT	COPPER ALLOY C2680	Au: 1U"min/Ni Plated	1SET
2	CONTACT	COPPER ALLOY C2680	Au: 1U"min/Ni Plated	1SET
1	HOUSING	HIGH TEMPERATURE PLASTIC	BLACK	1PCS
NO.	DESCRIPTION	MATERIAL	REMARKS	QTY

备注:

NO.	料号	胶芯颜色	电镀规格
1	UB08-81421019	黑色	1U"
2		黑色	3U"
3		黑色	5U"
4		黑色	30U"

东莞市全晟通精密制造有限公司
DONGGUAN QUAN SHENG TONG PRECISION MANUFACTURING CO. LID.

NAME (INTENDED USE) TYPE C F
PART NO. (INTENDED USE) UB08-81421H19
APPD: CHKD: kevin.huang
DR: kevin.huang 12/9-20

TITLE: CUSTOMER DRAWING
C/F 单排16P, L=6.50沉板1.0 CONN

DWG NO.: UB-0020

UNITS	SCALE	SHEET	REV.
mm	N/A	1/1	A0

