

RoHS Compliant Halogen Free

ECN NO.	REV	DATE	DESCRIPTION	APP'D
	AO	2021-9-7	drawing release	kevin

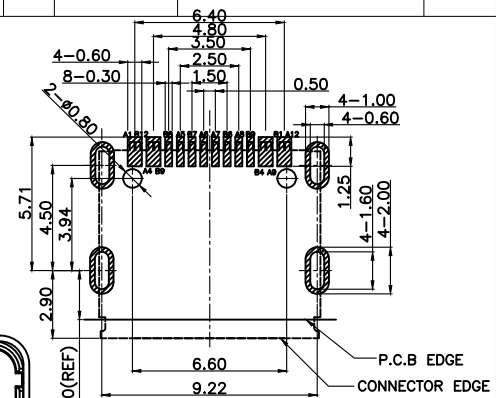

RECOMMENDED P.C.B. LAYOUT
TOLERANCE UNSPECIFIED ±0.05mm

A1	GND	B12	GND
A4	VBUS	B9	VBUS
A5	CC1	B8	SBU2
A6	DP1	B7	DN2
A7	DN1	B6	DP2
A8	SBU1	B5	CC2
A9	VBUS	B4	VBUS
A12	GND	B1	GND
PIN	SIGNAL NAME	PIN	SIGNAL NAME

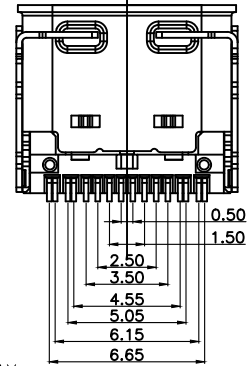
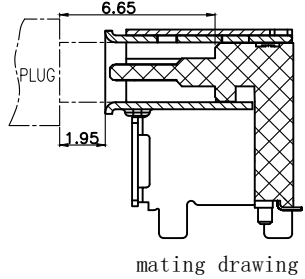
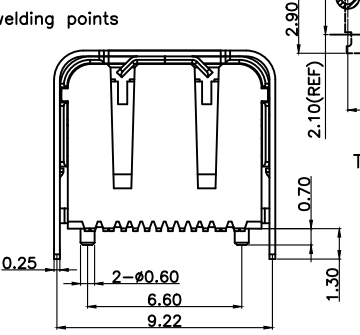
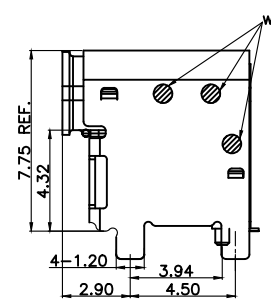
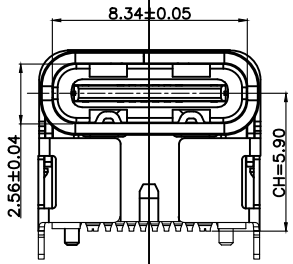
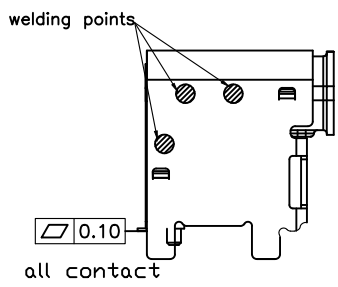

- NOTES:
SPECIFICATION:
1. CURRENT RATING: 5.0A MAX
2. VOLTAGE: 100 VAC
3. TEMPERATURE RANGE: -30 °C ~ 85 °C
4. CONTACT RESISTANCE: 40 MILLIONHM MAX
5. INSULATION RESISTANCE: 100 MEGOHMS MIN.
6. INSERTION FORCE : 5N~20N
7. UNMATING FORCE: 8N~20N
8. DURABILITY: 10,000 CYCLES
9. Salt spray: 24H

REFERENCE ONLY

NO.	DESCRIPTION	MATERIAL	REMARKS	QTY
7	OVER SHELL	STAINLESS STEEL SUS304	matte Ni Plated	
6	SHELL	STAINLESS STEEL SUS304	matte Ni Plated	1PCS
5	SHIELDING PLATE	STAINLESS STEEL SUS301	---	1PCS
4	MD	HIGH TEMPERATURE PLASTIC	BLACK	1PCS
3	CONTACT	COPPER ALLOY C7025-T0M	Au3 /Ni/Au1 U"	1SET
2	CONTACT	COPPER ALLOY C7025-T0M	Au3 /Ni/Au1 U"	1SET
1	HOUSING	HIGH TEMPERATURE PLASTIC	PA9T-BLACK	1PCS

LINEAR	ANGLE	NAME(INTENDED USE) TYPE C F
X. ±0.50	X° ± 2°	PART NO.(INTENDED USE)
.X ±0.30	.X° ± 1°	UB16-81421B26
.XX ±0.20	.XX° ± 0.5°	APPD:
.XXX ±0.10		CHKD: kevin.huang
GENERAL TOLERANCE UNLESS OTHERWISE NOTED		DR: kevin.huang 97-21

东莞市全晟通精密制造有限公司
DONGGUAN QUAN SHENG TONG PRECISION MANUFACTURING CO.,LTD.

TITLE: CUSTOMER DRAWING
C F 单排16P 架高型CH=5.90 母座

DWG NO.: UB-0026

UNITS	SCALE	SHEET	REV.
mm	N/A	1/1	AO