

ECN NO.	REV	DATE	DESCRIPTION	APP'D
	A0	2023-4-3	Drawing release	Kevin
	A1	2024-4-30	Drawing release	Kevin
	A2	2024-7-5	Drawing release	Kevin

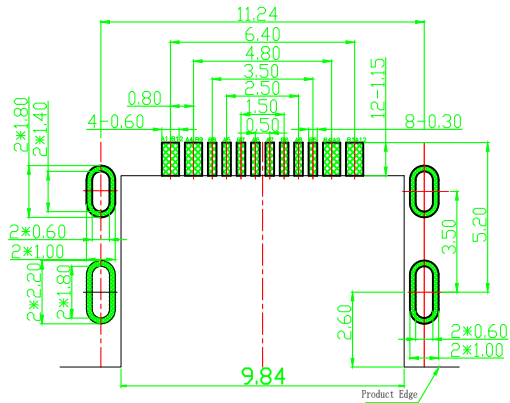

RECOMMENDED P.C.B. LAYOUT  
TOLERANCE UNSPECIFIED ±0.05mm

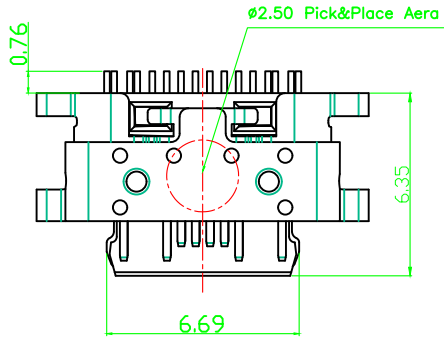
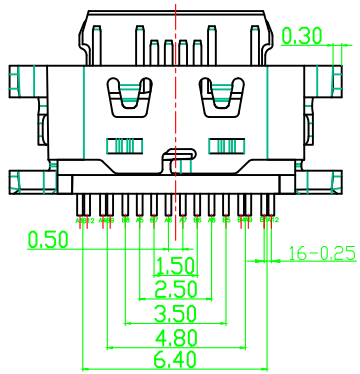
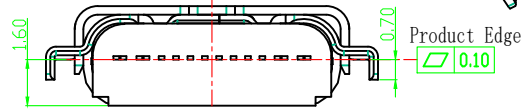
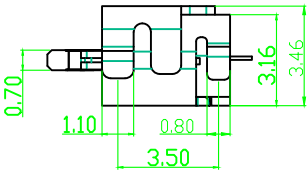
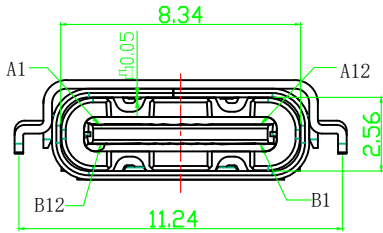
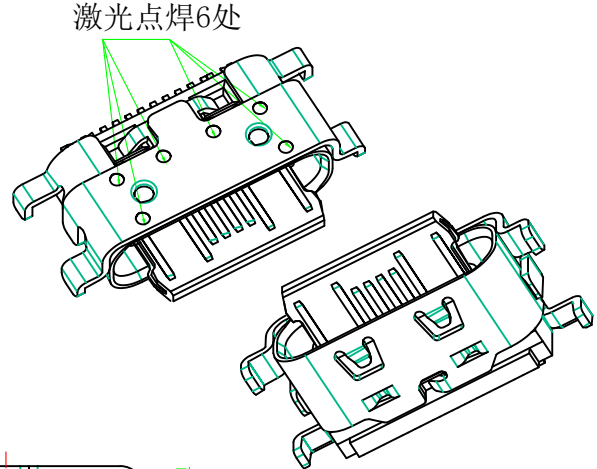

- NOTES:  
SPECIFICATION:
- CURRENT RATING: 5.0A MAX
  - VOLTAGE: 100 VAC
  - TEMPERATURE RANGE: -30 °C ~ 85 °C
  - CONTACT RESISTANCE: 40 MILLIONHM MAX
  - INSULATION RESISTANCE: 100 MEGOHMS MIN.
  - INSERTION FORCE : 5N~20N
  - UNMATING FORCE: 8N~20N
  - DURABILITY: 10,000 CYCLES

7	COVER SHELL	STAINLESS STEEL	Ni Plated	1PCS
6	SHELL	STAINLESS STEEL	Ni Plated	1PCS
5	SHIELDING PLATE	STAINLESS STEEL	---	1PCS
4	MD	HIGH TEMPERATURE PLASTIC	BLACK	1PCS
3	CONTACT	COPPER ALLOY	Au30+1U" /Ni Plated	1SET
2	CONTACT	COPPER ALLOY	Au30+1U" /Ni Plated	1SET
1	HOUSING	HIGH TEMPERATURE PLASTIC	PA9T-GP2450 BLACK	1PCS
NO.	DESCRIPTION	MATERIAL	REMARKS	QTY

A1	GND	B12	GND
A4	VBUS	B9	VBUS
A5	CCI	B8	SBU2
A6	DPI	B7	DN2
A7	DN1	B6	DP2
A8	SBU1	B5	CC2
A9	VBUS	B4	VBUS
A12	GND	B1	GND
PIN	SIGNAL NAME	PIN	SIGNAL NAME

LINEAR	ANGLE	NAME(INTENDED USE) TYPE C F
X. ±0.50	X°± 2°	PART NO.(INTENDED USE)
.X ±0.30	.X°± 1°	UB16-81421J18 双壳1.6
.XX ±0.20	.XX°± 0.5°	APPD:
.XXX ±0.10		CHKD: 黄文秋
GENERAL TOLERANCE UNLESS OTHERWISE NOTED		DR: 张婉姿 2024-7-5

东莞市全晟通精密制造有限公司  
DONGGUAN QUAN SHENG TONG PRECISION MANUFACTURING CO.,LTD.

TITLE: CUSTOMER DRAWING  
双壳 C型: 沉板1.60 CONN--A型电路

DWG NO.: UB-0018

UNITS	SCALE	SHEET	REV.
mm	N/A	1/1	A2