

ECN NO.	REV	DATE	DESCRIPTION	APP'D
	A0	20120325	drawing release	kevin

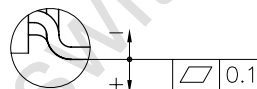
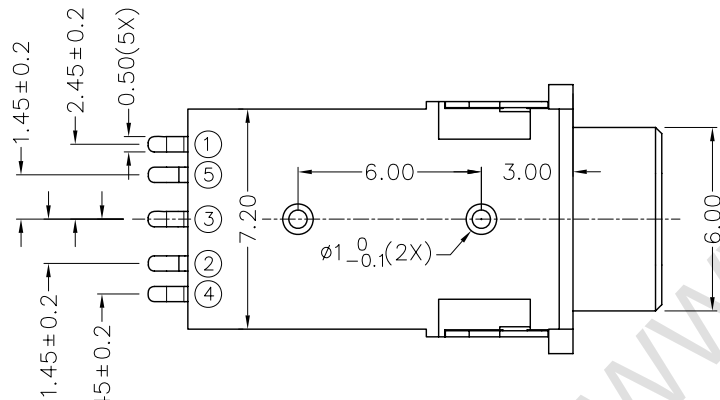
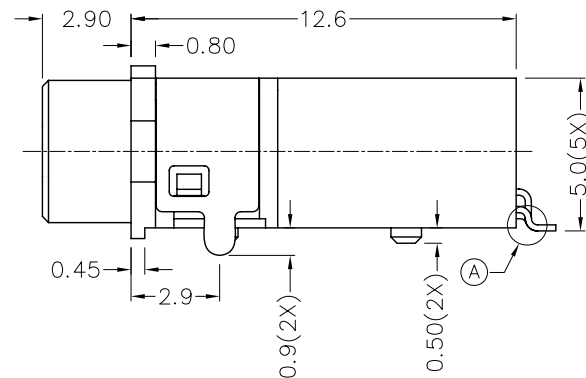
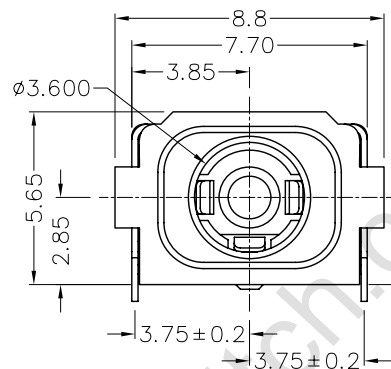
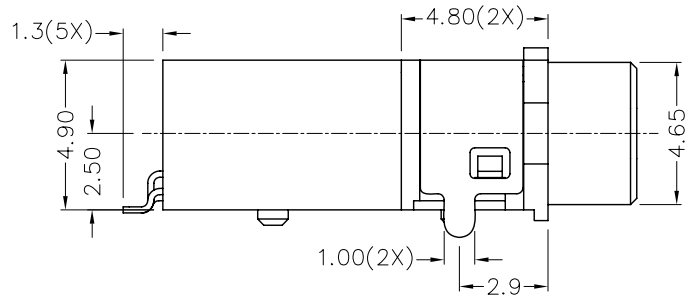
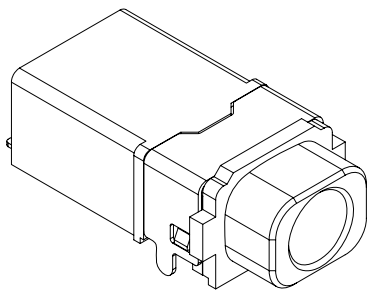

A DETAIL COPLANARITY

MATERIAL

- TERMINAL 1 : COPPER ALLOY
- TERMINAL 2 : COPPER ALLOY
- TERMINAL 3 : COPPER ALLOY
- TERMINAL 4 : COPPER ALLOY
- TERMINAL 5 : COPPER ALLOY
- SHIELD : BRASS
- HOUSING : PA6T
- COVER : PA6T

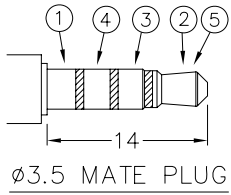
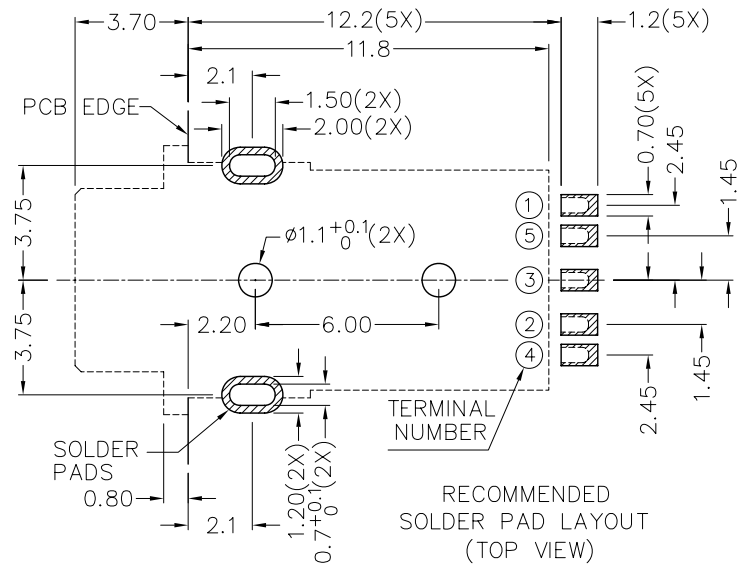
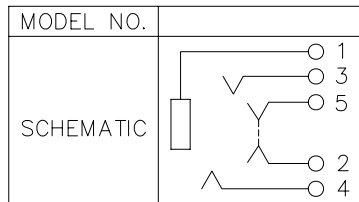

LINEAR	ANGLE	NAME(INTENDED USE) PHONE JACK	东莞市全晟通精密制造有限公司 DONGGUAN QUAN SHENG TONG PRECISION MANUFACTURING CO.,LTD
X.X ±0.30	X.X ±5	PART NO.(INTENDED USE) PJ06-8142311	
X.XX ±0.20	X.XX ±2	APPD:	
X.XXX ±0.10	X.XXX ±1	CHKD:	
GENERAL TOLERANCE UNLESS OTHERWISE NOTED		DR:	TITLE: CUSTOMER DRAWING PJ06-8142311 防水 DWG NO.: UNITS: mm SCALE: N/A SHEET: 1/1 REV: AO